

MECHANICAL :

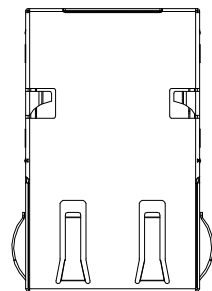

TOP VIEW

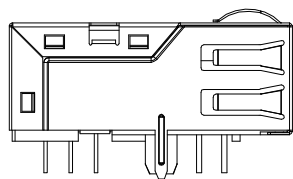

LEFT SIDE VIEW

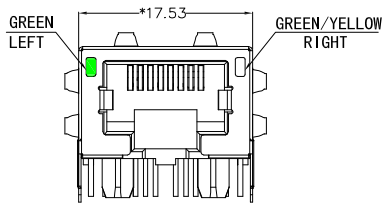

FRONT VIEW

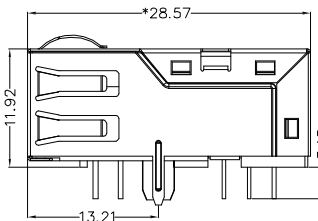

RIGHT SIDE VIEW

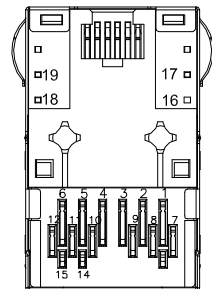

BOTTOM VIEW

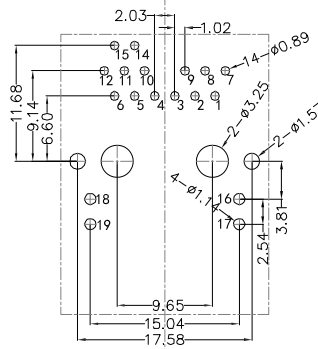

RECOMMENDED PCB LAYOUT VIEWED FROM COMPONENT SIDE

Metal Shell : Copper Alloy, Finish: 30u" Nickel
 Housing : Thermoplastic,PBT,UL 94V-0,Black
 Insert : Thermoplastic,PBT,UL 94V-0,Black
 Contact Terminal/phosphor Bronze
 6u" Gold on Contact Area, 100u" Tin on Solder,
 Both over 50u" Nickel Under-Plated
 Coil Base : Phenolic,PBT,UL 94V-0,Black
 Terminal/Copper Alloy T=0.35mm Thickness

Meets or exceeds IEEE 802.3 standard for 10/100 Base-TX
 350uH minimum OCL with 8mA Bias current
 Available with or without LEDs
 Minimum 1500Vrms isolation per IEEE802.3 requirement
 Operating temperature 0°C to +70°C
 Storage temperature -40°C to +85°C

LED ELECTRICAL CHARACTERISTIC

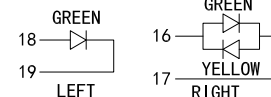

Standard LED	Wavelength	Forward V (Min/Max)	Forward A	Type
Green	568nm	1.8V/2.8V	20mA	squareness
Yellow	585nm	1.8V/2.8V	20mA	squareness
Orange	610nm	1.8V/2.8V	20mA	squareness

HULYN

深圳惠興力電子有限公司
 SHEN ZHEN HUILY ELECTRONICS CO.,LTD.

A0	RELEASED	Peng	02/08-17
REV	DESCRIPTION.	APPD.	Date

FILE NO : HRK3(Series)		TITLE 圖名		RJ45 Connector With Transformer 10G Tab-down 1x1 Port with LED		UNIT 單位	mm inch
TOLERANCE(公差): 0.000 mm ± 0.075 mm 0.00 mm ± 0.15 mm 0.0 mm ± 0.25 mm		PART NO. 料號		HRK3-1AB1T01-3M6BB-1R		SCALE 比例	1:1
		DRAWN BY 製圖		Peng	DATE 日期	2017-08-02	REV. 版本
		CHECKED BY 審核		Zhu	DATE 日期	2017-08-02	

SCHEMATICS:

Electrical:

1. Turn ratio: 8~9: J1~J2=1CT:1CT(±2%).
3~2: J3~J6=1CT:1CT(±2%).
4~5: J4~J5=1CT:1CT(±2%).
11~10 : J7~J8=1CT:1CT(±2%).
2. OCL: 160uH Min. at 100KHz 100mV 8mA DC.
3. Insertion Loss: -3.0 dB Max 100KHz.
-2.0 dB Max(-1.4dB TYP) 1~400MHz.
4. Return loss: -16dB Min 1~40MHz;
-16+10LOG(f/40)dB 40~400MHz.
-6+30LOG(f/400)dB 400~500MHz.
5. Cross talk: -28dB Min 1~100MHz;
-19dB Min 100~500MHz;
6. CMR: -30dB Min 1~40MHz;
-28dB Min 40~100MHz;
-26dB Min 100~500MHz;
7. CDMR: -30dB Min 1~250MHz;
-22dB Min 250~500MHz;
8. Hi-Pot: 2250V DC 6S 1mA PRI TO SEC

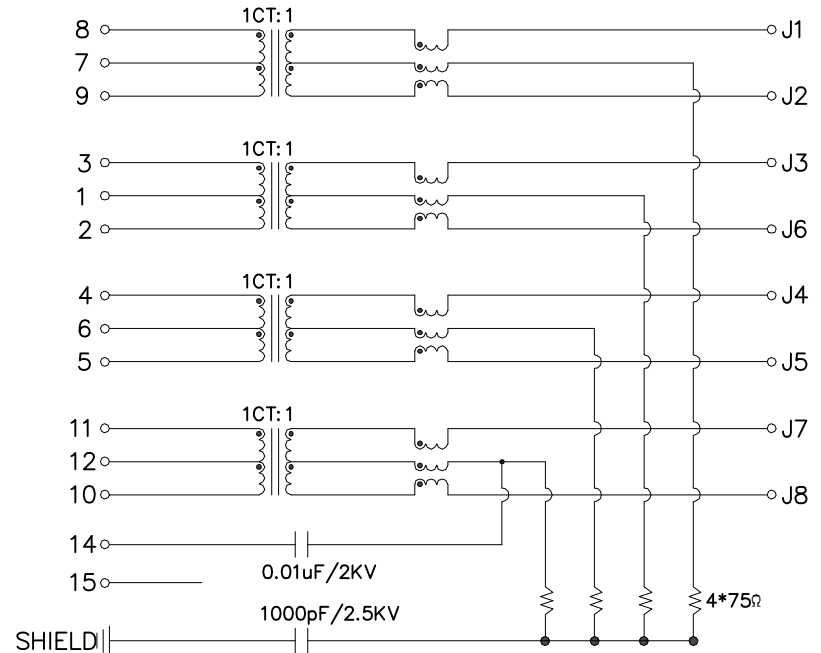

HULYN

深圳惠興力電子有限公司
SHEN ZHEN HUILY ELECTRONICS CO.,LTD.

A0	RELEASED	Peng	02/08-17
REV	DESCRIPTION.	APPD.	Date

FILE NO : HRK3(Series)		TITLE 圖名		RJ45 Connector With Transformer 10G Tab-down 1x1 Port with LED		UNIT 單位	mm inch
TOLERANCE(公差): 0.000 mm ± 0.075 mm 0.00 mm ± 0.15 mm 0.0 mm ± 0.25 mm		PART NO. 料號		HRK3-1AB1T01-3M6BB-1R		SCALE 比例	1:1
		DRAWN BY 製圖		Peng	DATE 日期	2017-08-02	REV. 版本
		CHECKED BY 審核		Zhu	DATE 日期	2017-08-02	